

Tuyaux Articulés 1/2" - Ø 12,7

ROSAGE



GROS DÉBIT
Ø 12,7 mm
1/2"

Équipement 1/2"

Équipement standard

Longueur : 330 mm



50-813

12 segments
 3 buses rondes : Ø 6,35 - 9,5 - 12,7 mm
 2 raccords mâles : 1 en 1/2" et 1 en 3/8" NPT

LOC-LINE 1/2" GROS DÉBIT

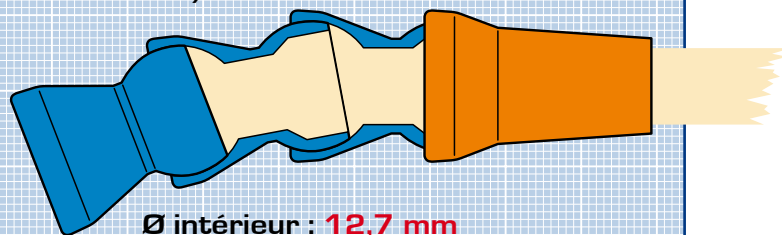

Ø intérieur : 12,7 mm

Pression maxi : 2 Bar

Débit : 30 litres / minute

Température d'utilisation maxi : 80°C

Raccords 3/8" et 1/2"

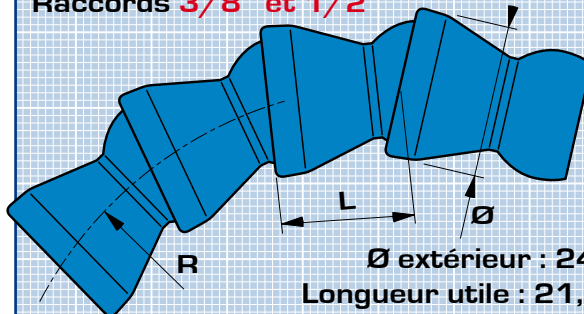

Ø extérieur : 24,9 mm

Longueur utile : 21,84 mm

Rayon de courbure mini : R 44 mm

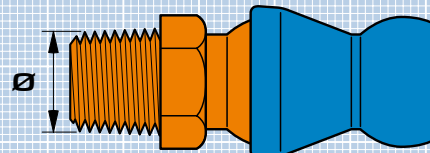

Filetages

NPT

BSP T

Filet à 60°

Filet à 55°

Ø - filets/pouce

Ø - filets/pouce

3/8"

17,3 mm 18

16,7 mm 19

1/2"

21 mm 14

21 mm 14

COMMENT UTILISER LOC-LINE AU MIEUX

Ligne bleue et orange "Acétal"

Oui	Acétone
Non	Acides
Oui	Alcool, éthyle
Non	Solution ammoniacale (forte)
Non	Bases (fortes)
Oui	Détergents commerciaux
Oui	Essence
Oui	Graisses
Non	Solutions d'ions hypochlorites
Oui	Solvants pour vernis
Oui	Huiles
Oui	Huiles solubles
Oui	Soude caustique
Non	Chlorate de sodium

Correspondance filetages

BSP T	Type
3/8"	12 x 17
1/2"	15 x 21

LOC-LINE noir disponible sur commande

Tuyaux Articulés 1/2" - Ø 12,7

Segments rotules

Segment standard	Réf.	
265 mm (12 pièces)	51-801	
1 mètre (46 pièces)	51-800	
7,5 mètres (345 pièces) 1 bobine	59-860	
15 mètres (690 pièces) 1 bobine	59-861	

Segment Long 90 mm : Assortiment

4 Segments longs, 4 Anneaux **51-835**

Segment long, 90 mm Réf.

Pochette de 4 **51-833**

Sachet de 20 **59-883**

Inclinaison : 28° maxi

Anneau de rigidité

Pochette de 4 **51-834**

Sachet de 20 **59-884**



Raccords filetés et Manchons taraudés

Raccord fileté Réf.

3/8" NPT

Pochette de 4 **51-804**

Sachet de 50 **59-864**

1/2" NPT

Pochette de 4 **51-805**

Sachet de 50 **59-865**

3/8" BSPT (Gaz)

Pochette de 4 **51-826**

Sachet de 50 **59-876**

1/2" BSPT (Gaz)

Pochette de 4 **51-827**

Sachet de 50 **59-877**

Manchon taraudé

3/8" NPT vers 3/8" NPT

Pochette de 4 **50-660** 6 pans 21

1/2" NPT vers 1/2" NPT

Pochette de 4 **50-661** 6 pans 26

Réducteur 3/8" - 1/4" NPT

Pochette de 4 **50-658** 6 pans 21

1/2" NPT vers 1/4" NPT

Pochette de 4 **50-659** 6 pans 26

Robinet et Segments spéciaux

Robinet Réf.

1/2" NPT mâle

Pochette de 2 **32-092**

Sachet de 10 **39-852**

1/2" NPT femelle

Pochette de 2 **32-093**

Sachet de 10 **39-853**

En ligne

Pochette de 2 **32-094**

Sachet de 10 **39-854**

Métallique 3/8" BSPT vers 3/8" BSPT

1 Robinet **50-310**

Valve anti-retour Réf.

Pochette de 2 **32-091**

Sachet de 10 **39-851**

Stoppe l'écoulement de liquide lorsque la pompe est arrêtée. Le liquide est immédiatement disponible et réduit le fonctionnement à sec des outils. Débit minimum garanti : 95%

Segment à jet central Réf.

1 trou Ø 3,5 mm

Pochette de 4 **51-836**

Bouchon obturateur Réf.

Pochette de 4 **51-838**

Cirque

Pochette comprenant : **51-837**

- 15 Segments
- 1 Bouchon
- Longueur : 620 mm
- Ø mini inter : 114 mm



ARROSAGE

Tuyaux Articulés 1/2" - Ø 12,7

ARROSAGE

Buses rondes

Buse ronde

Réf. 

1 trou Ø 6,35 mm
Pochette de 4
Sachet de 50



51-806
59-866

1 trou Ø 9,5 mm
Pochette de 4
Sachet de 50



51-802
59-862

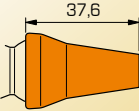

1 trou Ø 12,7 mm
Pochette de 4
Sachet de 50



51-803
59-863

Buse d'équerre

Réf. 

1 trou Ø 6,35 mm
Pochette de 4
Sachet de 20



51-828
59-878

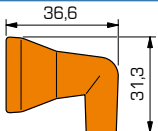

1 trou Ø 9,5 mm
Pochette de 4
Sachet de 20



51-829
59-879

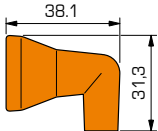

1 trou Ø 12,7 mm
Pochette de 4
Sachet de 20



51-830
59-880

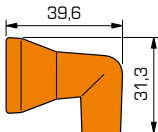

Assortiment de 4 Buses d'équerres

Pochette de 4 buses  51-832
Ø 6,35 - 9,5 - 12,7 - 8 trous Ø 4

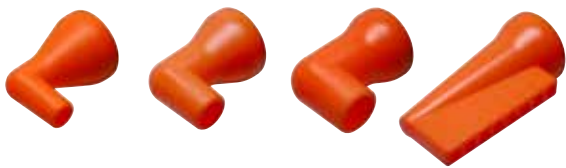

Buses plates

Buse plate

Réf. 

18 x 2 mm
Pochette de 4
Sachet de 20



51-840
59-890

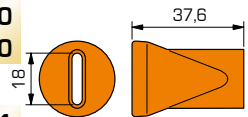

18 x 3,2 mm
Pochette de 4
Sachet de 20

51-841
59-891

Buse plate

Réf. 

31 x 4 mm
Pochette de 2
Sachet de 20



51-807
59-867

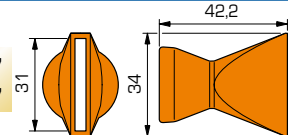

61 x 3 mm
Pochette de 2
Sachet de 20



51-809
59-871

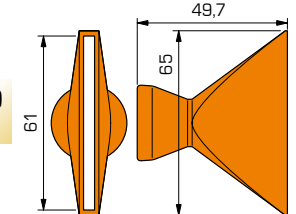

Buse à Jet Concentré

Réf. 

30 mm
Pochette de 2
Sachet de 20



51-847
59-897

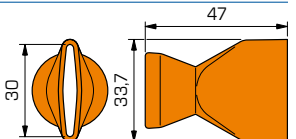

40 mm
Pochette de 2
Sachet de 20



51-848
59-898

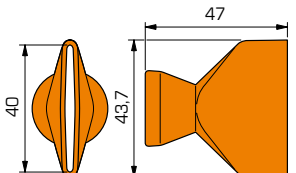

Buses multi-jets

Buse plate

Réf. 

7 trous Ø 2 mm
Pochette de 4
Sachet de 20



51-843
59-893

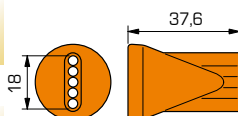

5 trous Ø 3,2
Pochette de 4
Sachet de 20

51-842
59-892

Buse orientable 63 mm

Réf. 

20 trous Ø 1,9 mm
L : 63 mm



51-845
59-895

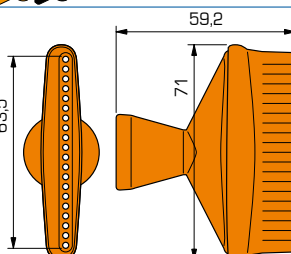

Pochette de 2
Sachet de 20

Buse d'équerre

Réf. 

8 trous Ø 4 mm
Pochette de 2
Sachet de 20



51-831
59-881

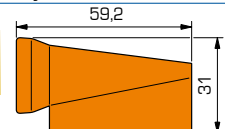

Assortiment de Buses

Assortiment de 16 Buses

Pochette

51-849

3 Buses rondes : Ø 6,35 - 9,5 - 12,7

3 Buses d'équerres : Ø 6,35 - 9,5 - 12,7

6 Buses plates : L 31 x 4 et 61 x 3

L 30 - 40 à jet concentré

L 18 x 2 et L 18 x 3,25

3 Buses multi-jets : 20 trous Ø 1,9

7 trous Ø 2 - 5 trous Ø 3,2

1 Buse d'équerre multi-jet : 8 trous Ø 4

Tuyaux Articulés 1/2" - Ø 12,7

Distributeurs et éléments de liaison

Élément de liaison

Dérivation en Y
1/2" vers 1/2"
Pochette de 2
Sachet de 20



Réf.  **51-808**
59-868

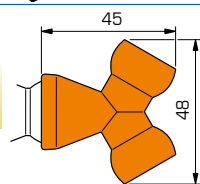

Manchon double femelle

Pochette de 4
Sachet de 20



Réf.  **51-811**
59-872

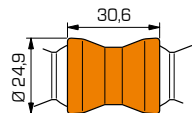

Adaptateur 1/2" vers 1/4"

Pochette de 2
Sachet de 20



Réf.  **51-821**
59-869

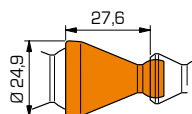

Adaptateur en Y

1/2" vers 1/4"
Pochette de 2
Sachet de 20



Réf.  **51-822**
59-870

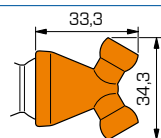

Élément de liaison

Coude mâle-femelle
1/2" vers 1/2"
Pochette de 2
Sachet de 20



Réf.  **51-824**
59-874

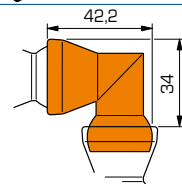

Dérivation en Té

1/2" vers 1/2"
Pochette de 2
Sachet de 20



Réf.  **51-825**
59-875

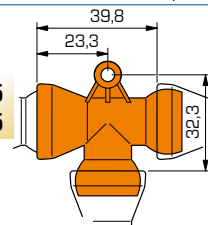

Support pour Manifold

Pochette de 2

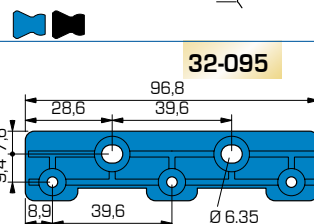

Distributeur standard

Manifold

1 support
3 dérivations en té
1 coude mâle-femelle



32-099

Distributeur complet

Manifold

1 support avec vis
3 dérivations en té
1 coude mâle-femelle
5 robinets en ligne



32-098

LOC-LINE noir disponible
sur commande 



LOC-LINE®

Pincés d'assemblage

1 Pince 1/2" **78-002**
2 Pincés **78-003**
1 en 1/4" et 1 en 1/2"



Utilisez le plus souvent possible
pour assembler et déboîter le tuyau
en toute sécurité.

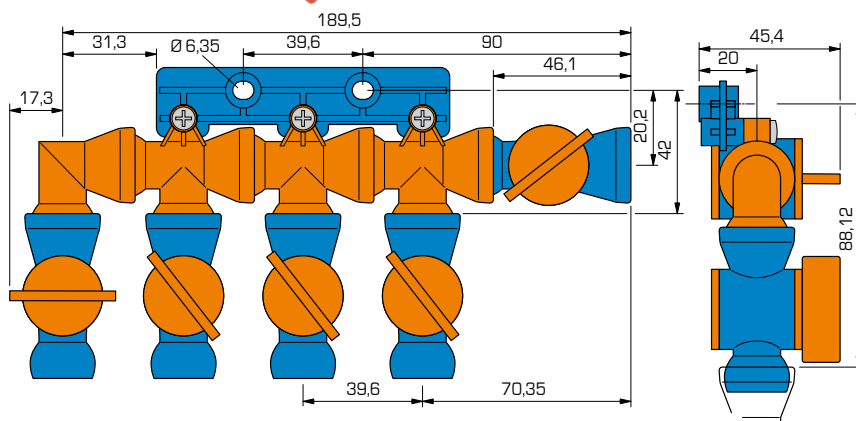

Rotule de fixation

Pochette de 2



51-895

Support d'écran de protection,
de détecteur, de caméra ...

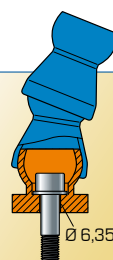

ARROSAGE